

PHILIPP ankerrail - koudgewalst - met doken

thermisch verzinkt - standaard schuimvulling van polyetheleen

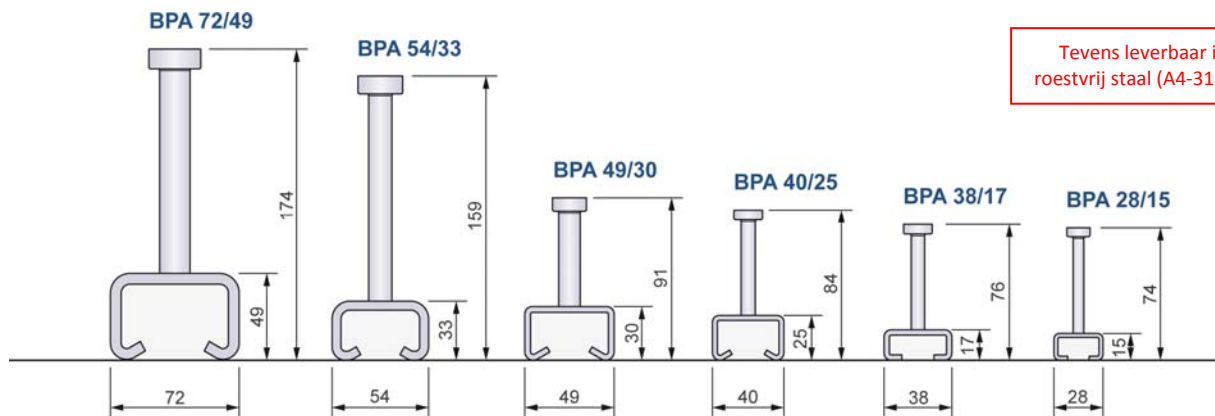

PHILIPP hamerkopbout

elektrolytisch verzinkt - kwaliteit 4.6

type PA 72/49 ②	type PA 54/33 ②	type PA 49/30 ②	type PA 40/25 ②	type PA 38/17 ①	type PA 28/15 ①
op aanvraag	M10 x 30	M10 x 30	M10 x 30	M10 x 20	M 6 x 15
op aanvraag	M10 x 40	M10 x 40	M10 x 40	M10 x 40	M 8 x 20
op aanvraag	M10 x 50	M12 x 30	M12 x 30	M10 x 60	M 8 x 25
op aanvraag	M12 x 40	M12 x 40	M12 x 40	M12 x 30	M 8 x 30
op aanvraag	M12 x 50	M12 x 50	M12 x 50	M12 x 40	M 8 x 40
op aanvraag	M12 x 60	M12 x 60	M12 x 60	M12 x 50	M 8 x 60
op aanvraag	M12 x 100	M12 x 80	M12 x 80	M12 x 60	M10 x 30
op aanvraag	M16 x 50	M12 x 150	M12 x 150	M16 x 40	M10 x 40
op aanvraag	M16 x 60	M16 x 40	M16 x 40	M16 x 50	M10 x 60
op aanvraag	M16 x 100	M16 x 50	M16 x 50	M16 x 60	M12 x 30
op aanvraag	M20 x 45	M16 x 60	M16 x 60	M16 x 80	M12 x 50
op aanvraag	M20 x 55	M16 x 125	M16 x 125		
op aanvraag		M16 x 150	M16 x 150		



Tevens leverbaar in roestvrij staal.

PHILIPP ankerrail - warmgewalst - met I-ankers
thermisch verzinkt - standaard schuimvulling van polyetheleen

Tevens leverbaar in roestvrij staal (A4-316Ti).

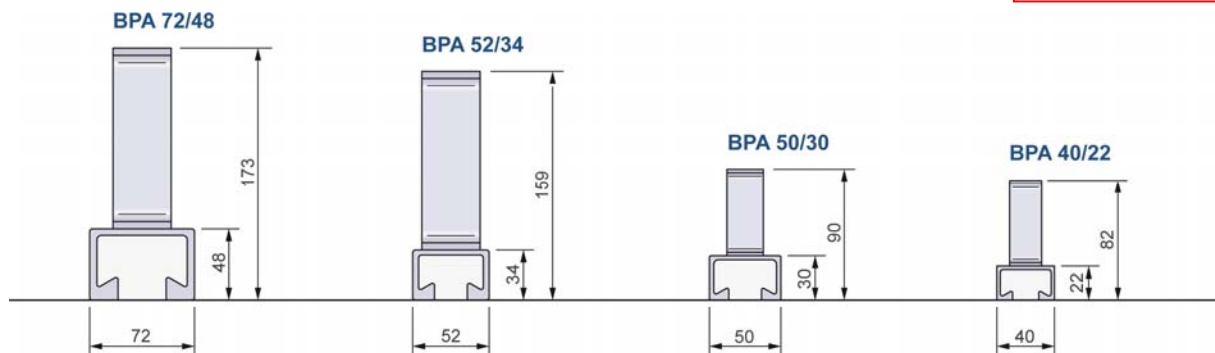

PHILIPP hamerkopbout
elektrolytisch verzinkt - kwaliteit 4.6

type PA 72/48 ②	type PA 52/34 ②	type PA 50/30 ②	type PA 40/22 ②
op aanvraag	M10 x 30	M10 x 30	M10 x 30
op aanvraag	M10 x 40	M10 x 40	M10 x 40
op aanvraag	M10 x 50	M10 x 50	M12 x 30
op aanvraag	M12 x 40	M12 x 40	M12 x 40
op aanvraag	M12 x 50	M12 x 50	M12 x 50
op aanvraag	M12 x 60	M12 x 60	M12 x 60
op aanvraag	M12 x 100	M12 x 100	M12 x 80
op aanvraag	M16 x 50	M16 x 50	M12 x 150
op aanvraag	M16 x 60	M16 x 60	M16 x 40
op aanvraag	M16 x 100	M16 x 100	M16 x 50
op aanvraag	M20 x 45	M20 x 45	M16 x 60
op aanvraag	M20 x 55	M20 x 55	M16 x 125
op aanvraag			M16 x 150



Tevens leverbaar in roestvrij staal.

PHILIPP ankerrail BPA 28/15

thermisch verzinkt - koudgewalst - met doken

trekkracht schuin/haaks (kN)	lengte (mm)	verankerings- diepte (mm)	aantal doken	artikel- nummer
3,5 / 3,4	100	69	2	82AS2815K0100FV
3,5 / 3,4	150	69	2	82AS2815K0150FV
3,5 / 3,4	200	69	2	82AS2815K0200FV
3,5 / 3,4	250	69	2	82AS2815K0250FV
3,5 / 3,4	300	69	2	82AS2815K0300FV
3,5 / 3,4	350	69	3	82AS2815K0350FV
3,5 / 3,4	400	69	3	82AS2815K0400FV
3,5 / 3,4	550	69	3	82AS2815K0550FV
3,5 / 3,4	1.050	69	5	82AS2815K1050FV
3,5 / 3,4	3.050	69	13	82AS2815K3050FV
3,5 / 3,4	6.070	69	25	82AS2815K6070FV



Tevens andere afmetingen leverbaar.

PHILIPP ankerrail BPA 28/15

roestvrij staal A4 - koudgewalst - met doken



trekkracht schuin/haaks (kN)	lengte (mm)	verankerings- diepte (mm)	aantal doken	artikel- nummer
3,5 / 3,4	100	69	2	82AS2815K0100VA
3,5 / 3,4	150	69	2	82AS2815K0150VA
3,5 / 3,4	200	69	2	82AS2815K0200VA
3,5 / 3,4	250	69	2	82AS2815K0250VA
3,5 / 3,4	300	69	2	82AS2815K0300VA
3,5 / 3,4	350	69	3	82AS2815K0350VA
3,5 / 3,4	400	69	3	82AS2815K0400VA
3,5 / 3,4	550	69	3	82AS2815K0550VA
3,5 / 3,4	1.050	69	5	82AS2815K1050VA
3,5 / 3,4	3.050	69	13	82AS2815K3050VA
3,5 / 3,4	6.070	69	25	82AS2815K6070VA

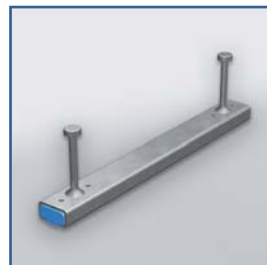

Tevens andere afmetingen leverbaar.

PHILIPP ankerrail BPA 38/17

thermisch verzinkt - koudgewalst - met doken

trekkracht schuin/haaks (kN)	lengte (mm)	verankerings- diepte (mm)	aantal doken	artikel- nummer
5,2 / 4,8	100	71	2	82AS3817K0100FV
5,2 / 4,8	150	71	2	82AS3817K0150FV
5,2 / 4,8	200	71	2	82AS3817K0200FV
5,2 / 4,8	250	71	2	82AS3817K0250FV
5,2 / 4,8	300	71	2	82AS3817K0300FV
5,2 / 4,8	350	71	3	82AS3817K0350FV
5,2 / 4,8	400	71	3	82AS3817K0400FV
5,2 / 4,8	550	71	3	82AS3817K0550FV
5,2 / 4,8	1.050	71	5	82AS3817K1050FV
5,2 / 4,8	3.050	71	13	82AS3817K3050FV
5,2 / 4,8	6.070	71	25	82AS3817K6070FV



Tevens andere afmetingen leverbaar.

PHILIPP ankerrail BPA 38/17

roestvrij staal A4 - koudgewalst - met doken



trekkracht schuin/haaks (kN)	lengte (mm)	verankerings- diepte (mm)	aantal doken	artikel- nummer
5,2 / 4,8	100	71	2	82AS3817K0100VA
5,2 / 4,8	150	71	2	82AS3817K0150VA
5,2 / 4,8	200	71	2	82AS3817K0200VA
5,2 / 4,8	250	71	2	82AS3817K0250VA
5,2 / 4,8	300	71	2	82AS3817K0300VA
5,2 / 4,8	350	71	3	82AS3817K0350VA
5,2 / 4,8	400	71	3	82AS3817K0400VA
5,2 / 4,8	550	71	3	82AS3817K0550VA
5,2 / 4,8	1.050	71	5	82AS3817K1050VA
5,2 / 4,8	3.050	71	13	82AS3817K3050VA
5,2 / 4,8	6.070	71	25	82AS3817K6070VA

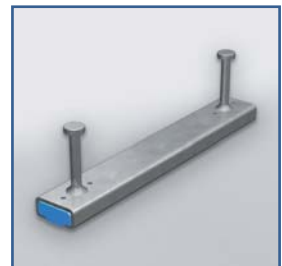

Tevens andere afmetingen leverbaar.

PHILIPP ankerrail BPA 40/25

thermisch verzinkt - koudgewalst - met doken

trekkracht schuin/haaks (kN)	lengte (mm)	verankerings- diepte (mm)	aantal doken	artikel- nummer
6,1 / 5,7	150	79	2	82AS4025K0150FV
6,1 / 5,7	200	79	2	82AS4025K0200FV
6,1 / 5,7	250	79	2	82AS4025K0250FV
6,1 / 5,7	300	79	2	82AS4025K0300FV
6,1 / 5,7	350	79	3	82AS4025K0350FV
6,1 / 5,7	400	79	3	82AS4025K0400FV
6,1 / 5,7	550	79	3	82AS4025K0550FV
6,1 / 5,7	1.050	79	5	82AS4025K1050FV
6,1 / 5,7	3.050	79	13	82AS4025K3050FV
6,1 / 5,7	6.070	79	25	82AS4025K6070FV

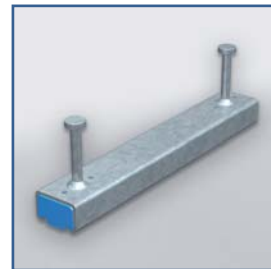

Tevens andere
afmetingen leverbaar.

PHILIPP ankerrail BPA 40/25

roestvrij staal A4 - koudgewalst - met doken



trekkracht schuin/haaks (kN)	lengte (mm)	verankerings- diepte (mm)	aantal doken	artikel- nummer
6,1 / 5,7	150	79	2	82AS4025K0150VA
6,1 / 5,7	200	79	2	82AS4025K0200VA
6,1 / 5,7	250	79	2	82AS4025K0250VA
6,1 / 5,7	300	79	2	82AS4025K0300VA
6,1 / 5,7	350	79	3	82AS4025K0350VA
6,1 / 5,7	400	79	3	82AS4025K0400VA
6,1 / 5,7	550	79	3	82AS4025K0550VA
6,1 / 5,7	1.050	79	5	82AS4025K1050VA
6,1 / 5,7	3.050	79	13	82AS4025K3050VA
6,1 / 5,7	6.070	79	25	82AS4025K6070VA

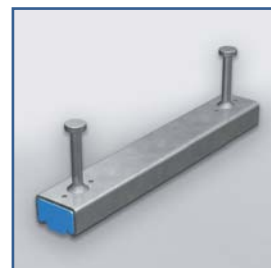

Tevens andere
afmetingen leverbaar.

PHILIPP ankerrail BPA 49/30

thermisch verzinkt - koudgewalst - met doken

trekkracht schuin/haaks (kN)	lengte (mm)	verankerings- diepte (mm)	aantal doken	artikel- nummer
9,8 / 9,2	150	84	2	82AS4930K0150FV
9,8 / 9,2	200	84	2	82AS4930K0200FV
9,8 / 9,2	250	84	2	82AS4930K0250FV
9,8 / 9,2	300	84	2	82AS4930K0300FV
9,8 / 9,2	350	84	3	82AS4930K0350FV
9,8 / 9,2	400	84	3	82AS4930K0400FV
9,8 / 9,2	550	84	3	82AS4930K0550FV
9,8 / 9,2	1.050	84	5	82AS4930K1050FV
9,8 / 9,2	3.050	84	13	82AS4930K3050FV
9,8 / 9,2	6.070	84	25	82AS4930K6070FV

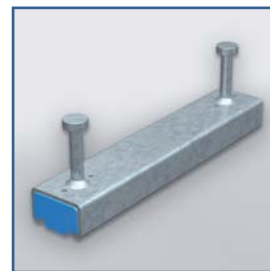

Tevens andere afmetingen leverbaar.

PHILIPP ankerrail BPA 49/30

roestvrij staal A4 - koudgewalst - met doken



trekkracht schuin/haaks (kN)	lengte (mm)	verankerings- diepte (mm)	aantal doken	artikel- nummer
9,8 / 9,2	150	84	2	82AS4930K0150VA
9,8 / 9,2	200	84	2	82AS4930K0200VA
9,8 / 9,2	250	84	2	82AS4930K0250VA
9,8 / 9,2	300	84	2	82AS4930K0300VA
9,8 / 9,2	350	84	3	82AS4930K0350VA
9,8 / 9,2	400	84	3	82AS4930K0400VA
9,8 / 9,2	550	84	3	82AS4930K0550VA
9,8 / 9,2	1.050	84	5	82AS4930K1050VA
9,8 / 9,2	3.050	84	13	82AS4930K3050VA
9,8 / 9,2	6.070	84	25	82AS4930K6070VA

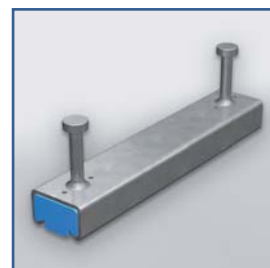

Tevens andere afmetingen leverbaar.

PHILIPP ankerrail BPA 54/33

thermisch verzinkt - koudgewalst - met doken

trekkracht schuin/haaks (kN)	lengte (mm)	verankerings- diepte (mm)	aantal doken	artikel- nummer
21,2 / 19,9	150	149	2	82AS5433K0150FV
21,2 / 19,9	200	149	2	82AS5433K0200FV
21,2 / 19,9	250	149	2	82AS5433K0250FV
21,2 / 19,9	300	149	2	82AS5433K0300FV
21,2 / 19,9	350	149	3	82AS5433K0350FV
21,2 / 19,9	400	149	3	82AS5433K0400FV
21,2 / 19,9	550	149	3	82AS5433K0550FV
21,2 / 19,9	1.050	149	5	82AS5433K1050FV
21,2 / 19,9	3.050	149	13	82AS5433K3050FV
21,2 / 19,9	6.070	149	25	82AS5433K6070FV



Tevens andere
afmetingen leverbaar.

PHILIPP ankerrail BPA 54/33

roestvrij staal A4 - koudgewalst - met doken



trekkracht schuin/haaks (kN)	lengte (mm)	verankerings- diepte (mm)	aantal doken	artikel- nummer
21,2 / 19,9	150	149	2	82AS5433K0150VA
21,2 / 19,9	200	149	2	82AS5433K0200VA
21,2 / 19,9	250	149	2	82AS5433K0250VA
21,2 / 19,9	300	149	2	82AS5433K0300VA
21,2 / 19,9	350	149	3	82AS5433K0350VA
21,2 / 19,9	400	149	3	82AS5433K0400VA
21,2 / 19,9	550	149	3	82AS5433K0550VA
21,2 / 19,9	1.050	149	5	82AS5433K1050VA
21,2 / 19,9	3.050	149	13	82AS5433K3050VA
21,2 / 19,9	6.070	149	25	82AS5433K6070VA

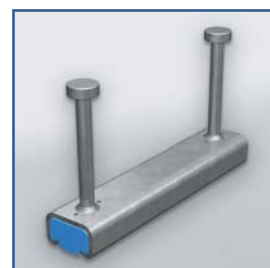

Tevens andere
afmetingen leverbaar.

PHILIPP ankerrail BPA 72/49

thermisch verzinkt - koudgewalst - met doken

trekkracht schuin/haaks (kN)	lengte (mm)	verankerings- diepte (mm)	aantal doken	artikel- nummer
30,9 / 29,5	150	164	2	82AS7249K0150FV
30,9 / 29,5	200	164	2	82AS7249K0200FV
30,9 / 29,5	250	164	2	82AS7249K0250FV
30,9 / 29,5	300	164	2	82AS7249K0300FV
30,9 / 29,5	350	164	3	82AS7249K0350FV
30,9 / 29,5	400	164	3	82AS7249K0400FV
30,9 / 29,5	550	164	3	82AS7249K0550FV
30,9 / 29,5	1.050	164	5	82AS7249K1050FV
30,9 / 29,5	3.050	164	13	82AS7249K3050FV
30,9 / 29,5	6.070	164	25	82AS7249K6070FV

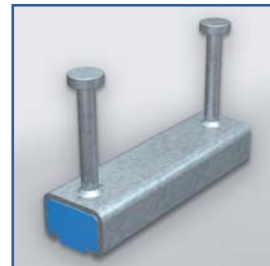

Tevens andere
afmetingen leverbaar.

PHILIPP ankerrail BPA 72/49

roestvrij staal A4 - koudgewalst - met doken



trekkracht schuin/haaks (kN)	lengte (mm)	verankerings- diepte (mm)	aantal doken	artikel- nummer
30,9 / 29,5	150	164	2	82AS7249K0150VA
30,9 / 29,5	200	164	2	82AS7249K0200VA
30,9 / 29,5	250	164	2	82AS7249K0250VA
30,9 / 29,5	300	164	2	82AS7249K0300VA
30,9 / 29,5	350	164	3	82AS7249K0350VA
30,9 / 29,5	400	164	3	82AS7249K0400VA
30,9 / 29,5	550	164	3	82AS7249K0550VA
30,9 / 29,5	1.050	164	5	82AS7249K1050VA
30,9 / 29,5	3.050	164	13	82AS7249K3050VA
30,9 / 29,5	6.070	164	25	82AS7249K6070VA



Tevens andere
afmetingen leverbaar.

PHILIPP ankerrail BPA 40/22

thermisch verzinkt - warmgewalst - met I-anker

trekkracht schuin/haaks (kN)	lengte (mm)	verankerings- diepte (mm)	aantal I-ankers	artikel- nummer
6,1 / 5,7	150	76	2	82AS4022I0150FV
6,1 / 5,7	200	76	2	82AS4022I0200FV
6,1 / 5,7	250	76	2	82AS4022I0250FV
6,1 / 5,7	300	76	2	82AS4022I0300FV
6,1 / 5,7	350	76	3	82AS4022I0350FV
6,1 / 5,7	400	76	3	82AS4022I0400FV
6,1 / 5,7	550	76	3	82AS4022I0550FV
6,1 / 5,7	1.050	76	5	82AS4022I1050FV
6,1 / 5,7	3.050	76	13	82AS4022I3050FV
6,1 / 5,7	6.070	76	25	82AS4022I6070FV

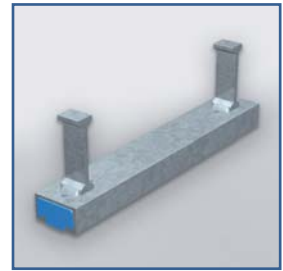

Tevens andere afmetingen leverbaar.

PHILIPP ankerrail BPA 40/22

roestvrij staal - warmgewalst - met I-anker



trekkracht schuin/haaks (kN)	lengte (mm)	verankerings- diepte (mm)	aantal I-ankers	artikel- nummer
6,1 / 5,7	150	76	2	82AS4022I0150VA
6,1 / 5,7	200	76	2	82AS4022I0200VA
6,1 / 5,7	250	76	2	82AS4022I0250VA
6,1 / 5,7	300	76	2	82AS4022I0300VA
6,1 / 5,7	350	76	3	82AS4022I0350VA
6,1 / 5,7	400	76	3	82AS4022I0400VA
6,1 / 5,7	550	76	3	82AS4022I0550VA
6,1 / 5,7	1.050	76	5	82AS4022I1050VA
6,1 / 5,7	3.050	76	13	82AS4022I3050VA
6,1 / 5,7	6.070	76	25	82AS4022I6070VA

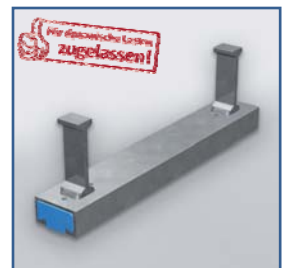

Tevens andere afmetingen leverbaar.

PHILIPP ankerrail BPA 50/30

thermisch verzinkt - warmgewalst - met I-anker

trekkracht schuin/haaks (kN)	lengte (mm)	verankerings- diepte (mm)	aantal I-ankers	artikel- nummer
9,8 / 9,2	150	84	2	82AS5030I0150FV
9,8 / 9,2	200	84	2	82AS5030I0200FV
9,8 / 9,2	250	84	2	82AS5030I0250FV
9,8 / 9,2	300	84	2	82AS5030I0300FV
9,8 / 9,2	350	84	3	82AS5030I0350FV
9,8 / 9,2	400	84	3	82AS5030I0400FV
9,8 / 9,2	550	84	3	82AS5030I0550FV
9,8 / 9,2	800	84	4	82AS5030I0800FV
9,8 / 9,2	1.050	84	5	82AS5030I1050FV
9,8 / 9,2	3.050	84	13	82AS5030I3050FV
9,8 / 9,2	6.070	84	25	82AS5030I6070FV



Tevens andere afmetingen leverbaar.

PHILIPP ankerrail BPA 50/30

roestvrij staal A4 - warmgewalst - met I-anker



trekkracht schuin/haaks (kN)	lengte (mm)	verankerings- diepte (mm)	aantal I-ankers	artikel- nummer
9,8 / 9,2	150	84	2	82AS5030I0150VA
9,8 / 9,2	200	84	2	82AS5030I0200VA
9,8 / 9,2	250	84	2	82AS5030I0250VA
9,8 / 9,2	300	84	2	82AS5030I0300VA
9,8 / 9,2	350	84	3	82AS5030I0350VA
9,8 / 9,2	400	84	3	82AS5030I0400VA
9,8 / 9,2	550	84	3	82AS5030I0550VA
9,8 / 9,2	1.050	84	5	82AS5030I1050VA
9,8 / 9,2	3.050	84	13	82AS5030I3050VA
9,8 / 9,2	6.070	84	25	82AS5030I6070VA

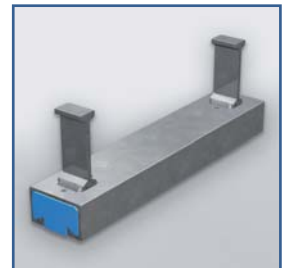

Tevens andere afmetingen leverbaar.

PHILIPP ankerrail BPA 52/34

thermisch verzinkt - warmgewalst - met I-anker

trekkracht schuin/haaks (kN)	lengte (mm)	verankerings- diepte (mm)	aantal I-ankers	artikel- nummer
21,2 / 19,9	150	149	2	82AS5234I0150FV
21,2 / 19,9	200	149	2	82AS5234I0200FV
21,2 / 19,9	250	149	2	82AS5234I0250FV
21,2 / 19,9	300	149	2	82AS5234I0300FV
21,2 / 19,9	350	149	3	82AS5234I0350FV
21,2 / 19,9	400	149	3	82AS5234I0400FV
21,2 / 19,9	550	149	3	82AS5234I0550FV
21,2 / 19,9	1.050	149	5	82AS5234I1050FV
21,2 / 19,9	3.050	149	13	82AS5234I3050FV
21,2 / 19,9	6.070	149	25	82AS5234I6070FV

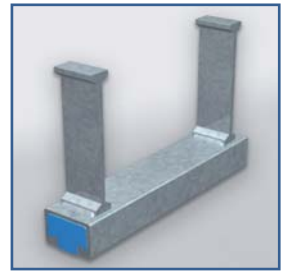

Tevens andere afmetingen leverbaar.

PHILIPP ankerrail BPA 52/34

roestvrij staal A4 - warmgewalst - met I-anker



trekkracht schuin/haaks (kN)	lengte (mm)	verankerings- diepte (mm)	aantal I-ankers	artikel- nummer
21,2 / 19,9	150	149	2	82AS5234I0150VA
21,2 / 19,9	200	149	2	82AS5234I0200VA
21,2 / 19,9	250	149	2	82AS5234I0250VA
21,2 / 19,9	300	149	2	82AS5234I0300VA
21,2 / 19,9	350	149	3	82AS5234I0350VA
21,2 / 19,9	400	149	3	82AS5234I0400VA
21,2 / 19,9	550	149	3	82AS5234I0550VA
21,2 / 19,9	1.050	149	5	82AS5234I1050VA
21,2 / 19,9	3.050	149	13	82AS5234I3050VA
21,2 / 19,9	6.070	149	25	82AS5234I6070VA



Tevens andere afmetingen leverbaar.

PHILIPP ankerrail BPA 72/48

thermisch verzinkt - warmgewalst - met I-anker

trekkracht schuin/haaks (kN)	lengte (mm)	verankerings- diepte (mm)	aantal I-ankers	artikel- nummer
30,9 / 29,5	150	163	2	82AS7248I0150FV
30,9 / 29,5	200	163	2	82AS7248I0200FV
30,9 / 29,5	250	163	2	82AS7248I0250FV
30,9 / 29,5	300	163	2	82AS7248I0300FV
30,9 / 29,5	350	163	3	82AS7248I0350FV
30,9 / 29,5	400	163	3	82AS7248I0400FV
30,9 / 29,5	550	163	3	82AS7248I0550FV
30,9 / 29,5	1.050	163	5	82AS7248I1050FV
30,9 / 29,5	3.050	163	13	82AS7248I3050FV
30,9 / 29,5	6.070	163	25	82AS7248I6070FV

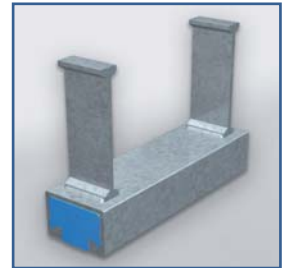

Tevens andere
afmetingen leverbaar.

PHILIPP ankerrail BPA 72/48

roestvrij staal A4 - warmgewalst - met I-anker



trekkracht schuin/haaks (kN)	lengte (mm)	verankerings- diepte (mm)	aantal I-ankers	artikel- nummer
30,9 / 29,5	150	163	2	82AS7248I0150VA
30,9 / 29,5	200	163	2	82AS7248I0200VA
30,9 / 29,5	250	163	2	82AS7248I0250VA
30,9 / 29,5	300	163	2	82AS7248I0300VA
30,9 / 29,5	350	163	3	82AS7248I0350VA
30,9 / 29,5	400	163	3	82AS7248I0400VA
30,9 / 29,5	550	163	3	82AS7248I0550VA
30,9 / 29,5	1.050	163	5	82AS7248I1050VA
30,9 / 29,5	3.050	163	13	82AS7248I3050VA
30,9 / 29,5	6.070	163	25	82AS7248I6070VA

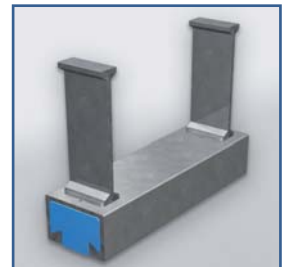

Tevens andere
afmetingen leverbaar.

De nieuwe ankerrail **ECORAIL™**

Ontwikkeld voor gebruik in zeer dunwandige prefab-elementen en voor lichte draagvermogens. De verkorte doken en de daarmee duidelijk gereduceerde totale verankeringsdiepte maken het mogelijk deze probleemloos te gebruiken in dunne, filigreine betonwanden en schachtelementen.

PHILIPP ECORAIL™ 28/15

thermisch verzinkt - koudgewalst - met doken

ECORAIL™

lengte (mm)	verankeringsdiepte (mm)	aantal doken	artikelnummer
150	40	2	82ECO2815K0150FV
200	40	2	82ECO2815K0200FV
300	40	2	82ECO2815K0300FV
350	40	3	82ECO2815K0350FV
550	40	3	82ECO2815K0550FV
3.050	40	13	82ECO2815K3050FV



PHILIPP ECORAIL™ 38/17

thermisch verzinkt - koudgewalst - met doken

ECORAIL™

lengte (mm)	verankeringsdiepte (mm)	aantal doken	artikelnummer
150	42	2	82ECO3817K0150FV
200	42	2	82ECO3817K0200FV
300	42	2	82ECO3817K0300FV
350	42	3	82ECO3817K0350FV
550	42	3	82ECO3817K0550FV
3.050	42	13	82ECO3817K3050FV



PHILIPP ECORAIL™ 40/25

thermisch verzinkt - koudgewalst - met doken

ECORAIL™

lengte (mm)	verankeringsdiepte (mm)	aantal doken	artikelnummer
150	50	2	82ECO4025K0150FV
200	50	2	82ECO4025K0200FV
300	50	2	82ECO4025K0300FV
350	50	3	82ECO4025K0350FV
550	50	3	82ECO4025K0550FV
3.050	50	13	82ECO4025K3050FV

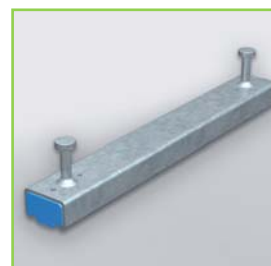

PHILIPP sandwichplaatbevestigingsrail BPU type A – 3 mm

thermisch verzinkt

lengte (mm)	aantal ankers	artikelnummer
3.000	7	82TS3A300007
3.000	8	82TS3A300008
3.000	20	82TS3A300020

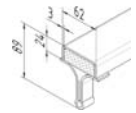
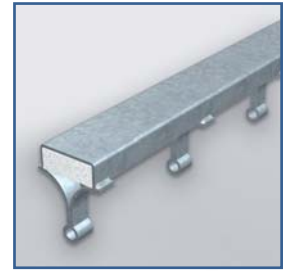

PHILIPP sandwichplaatbevestigingsrail BPU type B – 3 mm

thermisch verzinkt

lengte (mm)	aantal ankers	artikelnummer
3.000	14	82TS3B300014
3.000	16	82TS3B300016
3.000	40	82TS3B300040

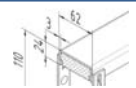

kikkerplaat staal

thermisch verzinkt met gat Ø 13 mm

zet-hoogte (mm)	lengte (mm)	plaat-dikte (mm)	plaat-breedte (mm)	artikelnummer
8	95	8	40	KIKKERPL08
12	95	8	40	KIKKERPL12
16	95	8	40	KIKKERPL16
20	95	8	40	KIKKERPL20
24	95	8	40	KIKKERPL24
30	95	8	40	KIKKERPL30

